

MODEL P-3900

Specifications

Total Stroke 30 mm (1.2 in)
 Total Grip Force at 6.2 bar/90 psi
 Open 4580 N (1030 lbf)
 Close 4198 N (940 lbf)
 Grip Force per Jaw at 6.2 bar/90 psi
 Open 1527 N (343 lbf)
 Close 1399 N (313 lbf)
 Mass 9.4 kg (20.8 lb)
 Bore Diameter 100 mm (3.94 in)
 Max. Operating Pressure 8.3 bar (120 psi)

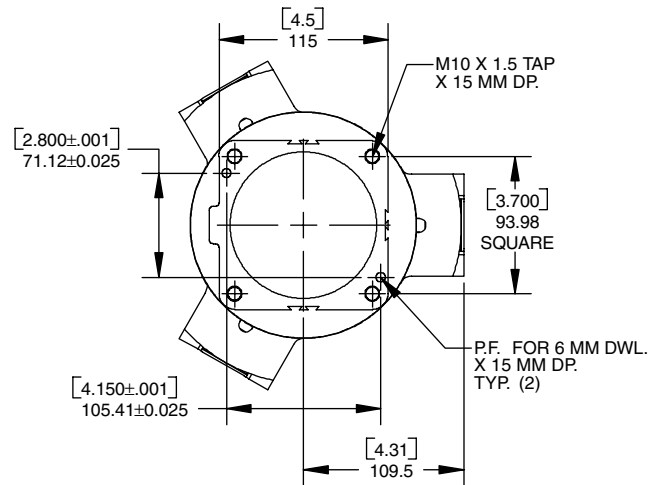

P-3900
Grip Force Close vs. Finger Length

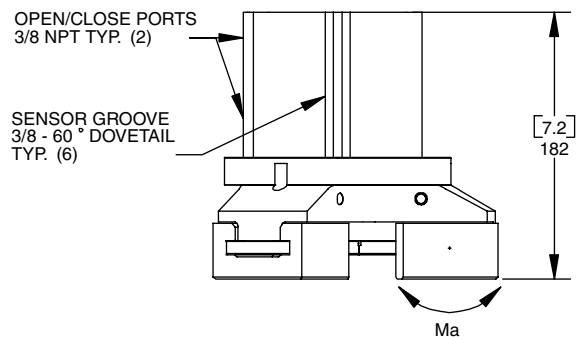
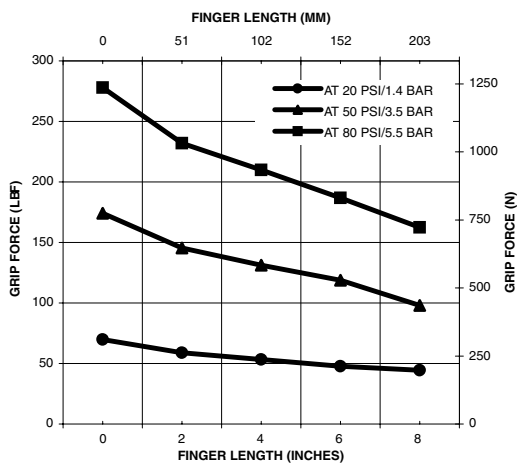

P-3900
Grip Force per Jaw vs. Pressure

